

**PLANS**

**FOR**

**CONSTRUCTING**

**AN**

**ORGONE**

**ENERGY**

**ACCUMULATOR**

Based on information originally distributed by the Wilhelm Reich Foundation

## **Notes Regarding the Use of the Orgone Accumulator**

The Orgone Accumulator is built so as to collect the natural energy of the atmosphere (Orgone Energy) and to make this energy about five times more concentrated inside the accumulator than in the outside air. Since orgone is the same energy that is in the bodies of all living organisms, the accumulator has the effect of increasing the body energy of the user--increasing the natural charge of the user's tissue and blood--thus strengthening the user's resistance to disease.

Orgone is not electricity, and the orgone accumulator has no electrical connections. **WARNING: DO NOT ALLOW EXPOSED ELECTRICAL WIRES TO COME IN CONTACT WITH THE ACCUMULATOR!**

The accumulator should be used once or twice daily as follows: the user should sit inside the accumulator lightly clothed or without clothing until the user becomes quite warm, or for roughly 15 to 45 minutes. The effect of the orgone will be best if the user relaxes, breathing out deeply but not forcefully. Slight dizziness or heaviness in the head is a signal to come out. Fresh air will eliminate such effects immediately.

In humid weather, the normal time of use should be lengthened, as there is then less orgone in the atmosphere. Air the room in which the accumulator is kept every day, for the increased orgone concentration tends to make the air in the room heavy.

The funnel end from the shooter box-seat is used for local application of orgone. This unattached end should be held close to, but not quite touching, the region in question for between two and ten minutes, depending on the sensitivity of the region. If it is used on the eyes, they should be kept closed. A slight burning sensation in the region that is being treated is a signal that the body has had enough for the time being. In general, the tube should only be used until the area becomes warm. The shooter box-seat tube can be used several times a day.

## Questions Regarding the Use of the Orgone Accumulator

- Q. Does it lessen the effect of the accumulator if any part of the body comes in direct contact with the metal walls?
- A. It is better if no part of the body touches the metal walls. However this cannot always be avoided and it does not lessen the effect to any considerable degree.
- Q. If two or three people use an accumulator rapidly in succession, is the orgone "used up"; does the last one to use it get energy?
- A. The effect of the orgone accumulator consists of a mutual excitation of the orgone energy which is concentrated within the accumulator and the body-orgone energy of the user. It can be assumed that the successive use of the accumulator by several persons will not lessen the efficacy.
- Q. Should you spend more or less time in the accumulator, depending on the humidity?
- A. Since the orgone energy concentration in the atmosphere diminishes with high humidity, it is advisable to prolong the use of the accumulator on very humid days.
- Q. Does the funnel for the pipe of the tube box have to be metal?
- A. Yes, since plastic or other non-metallic material will tend to "hold" orgone energy, while the metal will give it off immediately.
- Q. Can you use the tube box inside a larger accumulator for reasons of more intensity, or is it more advisable to use it outside?
- A. The concentration of orgone energy in the tube box will be stronger if it is used within the larger accumulator.
- Q. Is it all right to take objects into the accumulator while using it, such as books, magazines, notebook, pen, pillow?
- A. There is no objection to taking reading or writing material into the accumulator or knitting or needlework, etc. We would advise against taking pillows into the accumulator because they will soak up orgone energy and thus divert it from the body.
- Q. Is it all right to paint the accumulator to match walls?
- A. As long as the paint does not contain lead or other metals, the accumulator can be painted in any color. It may also be covered with wallpaper.

- Q. If one makes one's accumulator light-tight and then sits inside it, is it possible to see the orgone energy light phenomena that are described in *The Cancer Biopathy*?
- A. No; bodily evaporation under these conditions creates too much humidity and the orgone phenomena cannot be seen when the humidity is high.
- Q. What is the difference in strength between a one layer and three layer accumulator?
- A. The one layer accumulator, has an orgone concentration, measured electroscopically, of about 3 times that of the surrounding atmosphere. The three layer accumulator, has an orgone concentration of about 4 to 5 times that of the surrounding atmosphere. However, the concentration of the orgone energy does not increase proportionally with the numbers of layers. Thus a tenfold accumulator will have a concentration of approximately 6 times that of the surroundings.
- Q. My accumulator does not fit tightly together. Does this in any way lessen the effectiveness?
- A. Occasionally when an accumulator is dismantled and put together again, the walls do not close tightly. These cracks, even if they are as large as one inch, do not in any way affect the strength of the accumulator. In fact, experimental accumulators have been built with openings at the top and bottom for circulation purposes.
- Q. Can paper, felt or material other than fiberglass be used for the non-metallic layers of the accumulator?
- A. Experiments have been made with other materials. However, all these materials are liable to absorb humidity, whereas the fiberglass will not absorb any humidity. Too strong an absorption of humidity would definitely lower the strength of the accumulator.
- Q. If you go into the accumulator with a fever, is the fever increased?
- A. In most cases, experience shows that the fever will be slightly increased while the person uses the accumulator, but that the temperature will drop below the previous level after the use of the accumulator.
- Q. Is there any special time of day when the accumulator is more effective than at other times?
- A. Electroscopic measurements show the greatest concentration of orgone energy between 12 noon and 2 p.m. However, these variations in a given day are so small that it will not make any significant difference at what time of the day the accumulator is used. It can easily be regulated by timing.

## Construction of a Three-Fold Orgone Energy Accumulator

### 1. General information

a. The accumulator is made of six panels which are to be screwed together. All panels except the bottom are constructed in the same manner, and differ only in dimensions. Each panel consists of an inner surface of galvanized sheetmetal and an outer non-metallic surface of celotex which encloses a braced wood frame and alternate layers of fiberglass and steelwool.

b. The materials specified may, if necessary, be replaced by other materials: 1/4" plexiglass or 1/4" upsonite along with a 1/4" fiberglass layer may be used in place of the 1/2" celotex. If substitutions are made, some adjustments in dimensions of the frames may be necessary.

c. Consult the accompanying drawings and tables for dimensions, construction details, etc.

### 2. Construct the frames

a. Cut the 1 1/8" x 1 1/2" clear pine to the specified lengths ( see fig. 1). Cut a 1/2" x 1/2" rabbet into one side of each piece (see fig. 2). The bottom panel frame requires two 1/4" x 1/2" rabbets (see fig. 3). Mitre the corners and join with carpenters' glue and 8-penny finish nails.

b. Brace each frame with two pieces of 1 1/8" x 1" clear pine (see fig. 4). Join with two 2 1/2" #8 drywall screws. The top and bottom frame do not need bracing.

### 3. Attach the outer surface

a. Cut the celotex to fit inside the rabbets of each frame except for the bottom frame. Fasten in place with 1" galvanized wire nails.

---

1. For a five-fold accumulator, increase the dimensions of the frames to allow for four more 1/4" layers, two layers of fiberglass and two layers of steelwool.

2. The 1/2" celotex (which has one side coated with white primer paint) may be known as: white construction board, soundboard, etc. It is basically a composite of wood fibers. Flakeboard, chipboard, etc. are not the same product and are too dense. There is a styrofoam product with the trademark name Celotex; do not use this.

3. fiberglass building insulation

4. What is referred to as 5/4" stock by the building industry actually measures 1 1/8 inch.

b. Cut two pieces of 1/4" finish grade plywood to fit inside the rabbets of the bottom frame. Fasten one piece in place with 1" galvanized wire nails.

4. Place the steelwool and fiberglass in the panels

a. Place a layer of steelwool upon the celotex inside one of the frames. Steelwool pads (oo fine or finer) when unrolled are the correct thickness. Make the layer as uniform as possible; leave the steel wool fluffy.

b. Next place a layer of fiberglass about 1/4" thick upon the steelwool layer. Avoid lumps and holes. Do not compress the fiberglass. The standard 3 1/2" x 15" fiberglass insulation comes in a roll with either a paper or foil backing. Peel off the paper or foil. This type of fiberglass is difficult to peel evenly. Try to peel it carefully into roughly 1/4" thick pieces. Too much unevenness in the layering will cause the sides of the accumulator to bulge. (There is a fiberglass insulation that peels more uniformly but might be difficult to purchase. It is a Manville product called 1/2" duct liner. It comes in a roll 48" wide by 100 feet long and may be available at your local heating and airconditioning shop.)

c. In a similar manner place the remaining alternate layers of steelwool and fiberglass in position ( see fig 2).

d. Place the steelwool and fiberglass layers in the other panels.

e. The bottom panel has a different number of layers. Start with a layer of fiberglass upon the 1/4" plywood inside the frame (see fig. 3).

5. Attach the inner surfaces

a. Cut the sheetmetal slightly smaller than the frames. You might need to have the 26 or 28 gage galvanized sheetmetal cut at a sheetmetal shop. It can be cut by hand, but the results may be too rough. File the edges smooth and round the corners. Cut a 9" x 12" hole for the window in one of the 53" x 24" sheets. Figure 4 will give the exact location.

b. Drill 1/8" holes at 1" intervals around the edge of the sheetmetal. They should be 1/4" from the edge.

c. Nail the pieces of sheetmetal to the frames with 3/4" galvanized wire nails. Nail the remaining piece of 1/4" plywood to the bottom frame before nailing the final piece of sheetmetal over it. (See fig. 3)

---

5. Wear protective clothing and a dust mask when handling the steelwool and fiberglass.

6. Steelwool in long rolls can be purchased from an industrial supplier.

6. Attach supports to the bottom panel

- a. Cut two pieces of 1 1/8" x 1 1/2" clear pine 25" long.
- b. Screw them into the outer surface of the panel. (See fig 3.)
- c. Nail two furniture slides to the undersurface of each support.

7. Assemble the accumulator

Accuracy is necessary in fastening the sides, top, bottom and door of the accumulator. You will want to be able to take apart and put back together your accumulator in the event that you need to transport it. It is very bulky when assembled.

- a. Pre-drill holes for the 2 1/2" #10 flathead philips screws with a 3/16" drill bit. So that the screw heads will countersink, drill a 1/2" hole 1/4" deep. Figure 5 gives the locations of these holes.
- b. Lay the two side panels upright on their long sides. Place the bottom panel upright against the bottom ends of the two side panels and screw together. Then place the top panel upright against the top ends of the two side panels and screw together. Place the back panel onto the side panels between the overlaps of the top and bottom panels and screw together (figure 5).
- c. Turn the box over onto its back and place the door on the side panels. Make sure that the door is flush with the top of the box (this will leave a one-inch gap at the bottom to allow air circulation). Mount the hinges to the side panel and to the door (fig. 6). You can hang the door to open either left or right.
- d. Now stand the accumulator up.
- e. You will need a hook and eye to hold the door closed while you sit in the accumulator. Place it where most convenient.

8. Assemble the seat for the accumulator

You have two options. The simplest is to suspend a piece of 3/4" x 14" x 22" wood on two supports fastened to the lower support braces of the two side panels. The other option is to turn the seat into a combination shooter box and chest panel.

### Construct the shooter box-seat

a. Construct two panels in a manner similar to the other panels as explained in sections 2 through 6. 1/4" finish grade plywood is needed for the top and front of the seat panels ( fig. 7).

b. Prepare supports to hold the shooter box-seat panels. Cut four pieces of 1 1/8" x 1 1/2" pine 12 1/2" long. Fasten two 12 1/2" pieces to the lower supports in the side panels with 2" #8 drywall screws. Then fasten the other two pieces vertically between the horizontal support and the floor of the accumulator with 2" screws. Fasten one 14" x 21 3/4" panel to the horizontal cleat A with 2 1/2" drywall screws. The other 14" x 21 3/4" panel will rest against the vertical cleats B (fig. 8). Do not fasten this panel. Attach a cabinet pull (metal or ceramic) to the front of this panel so you can easily remove it to use as a chest panel (fig. 9).

### 9. Construct a shooter funnel for the box seat

a. Take a four-foot length of 3/8" steel Greenfield casing. (Greenfield casing can be purchased from an electrical supply store. If you can't find it, you can substitute #12 BX electrical cable, but remove the wiring from the flexible metal casing before using.)

b. Insert the spout of a 3" diameter galvanized sheetmetal funnel into one end of the flexible metal casing. Wrap carefully the outside of both the flexible casing and the funnel with plastic electricians tape, so that no metal is showing. Drill a 5/8" hole through the top back corner of the accumulator box seat's top panel. Push the flexible tubing into the space below.

### 10. Optional

In order to draw stagnant orgone energy from the accumulator and shooter box seat:

a. You will need approximately three 48" lengths of 3/8" Greenfield casing. Use more or less than three depending on individual circumstances.

b. Drill three 5/8" holes (in a vertical row) through the wood frame of one of the side panels. Make sure that one hole will lead into the shooter box seat. Insert the three casings into the three holes. Make sure that the casings don't protrude inside of the accumulator.

---

7. Greenfield casing is a convenient hollow flexible metal tube. IT IS NOT an electrical connection and should NOT be used as one.



c. Place the loose ends of the three casings into a pail of clean water. You need to change the water every week.

#####

The principle of the accumulator box can be adapted to different shapes for specific needs. An orgone blanket, or a collar for the neck, or a large funnel for the breast can be made as long as the principle of alternating layers of non-metallic and metallic materials is maintained.

---

8. The inner surface should be made of a flexible metal screen instead of galvanized sheetmetal. Screen made from galvanized steel or stainless steel is good. Screen made from copper, aluminum and other metals that are not body-own are NOT recommended.

## MATERIALS LIST

ITEM	APPROXIMATE QUANTITY
1/2" celotex	four 4' x 8' sheets
galvanized sheetmetal (26 or 28 gage)	2 pieces 53" x 26 1/2"
"    "    "    "	2 pieces 53" x 24"
"    "    "    "	2 pieces 28" x 24"
fiberglass insulation	3 1/2" x 15" (1 roll or 40 linear feet)
steelwool (oo fine or finer)	200 pads or 10 lbs.
1/4" plywood ( finish grade)	one 4' x 8' sheet
clear white pine: 1 1/8" x 1 1/2"	80 linear feet
"    "    "    1 1/8 x 1"	20 linear feet
2 1/2" #10 philips flathead wood screws	30 pcs.
2 1/2 #8 drywall screws	30 pcs.
2" #8 drywall screws	10 pcs.
3" non-mortise or surface mounted hinges	one pair
hook and eye	one 2"
nail-on furniture glides	4 pcs.
nails: 3/4" galvanized wire nails	3 oz.
1" galvanized wire nails	3 oz.
6-penny finish nails	2 lbs.
carpenters' glue	one small bottle
<u>For the shooter box seat panels:</u>	
galvanized sheet metal (26 or 28 gage)	2 pieces 13" x 20 3/4"
clear white pine: 1 1/8" x 1 1/2"	16 linear feet
3" diameter galvanized sheetmetal funnel	one
3/8" Greenfield flexible metal casing	16 feet
electricians' tape (plastic tape)	one roll

(FIG. 1)

TABLE OF DIMENSIONS

PANEL	LENGTH	WIDTH
TOP	29"	25"
BOTTOM	29"	25"
SIDES (2)	54"	27 1/2"
BACK	54"	25"
DOOR	54"	25"
SEATS (2)	14"	21 3/4"

(FIG. 2)

DETAIL OF LAYERING OF SIDES (2)  
TOP, BACK AND DOOR PANELS

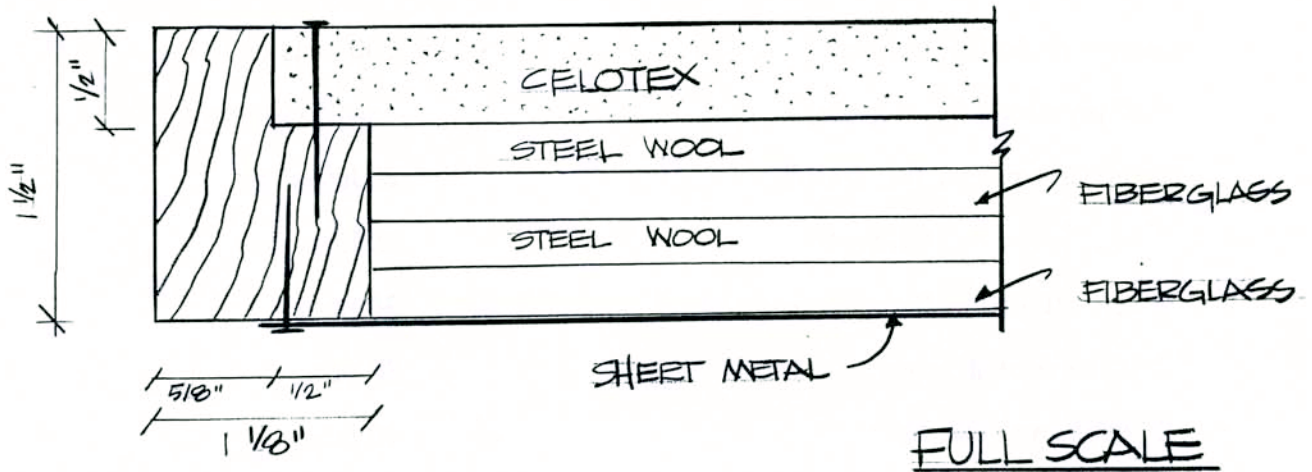

(FIG. 3)

DETAIL OF LAYERING - BOTTOM PANEL

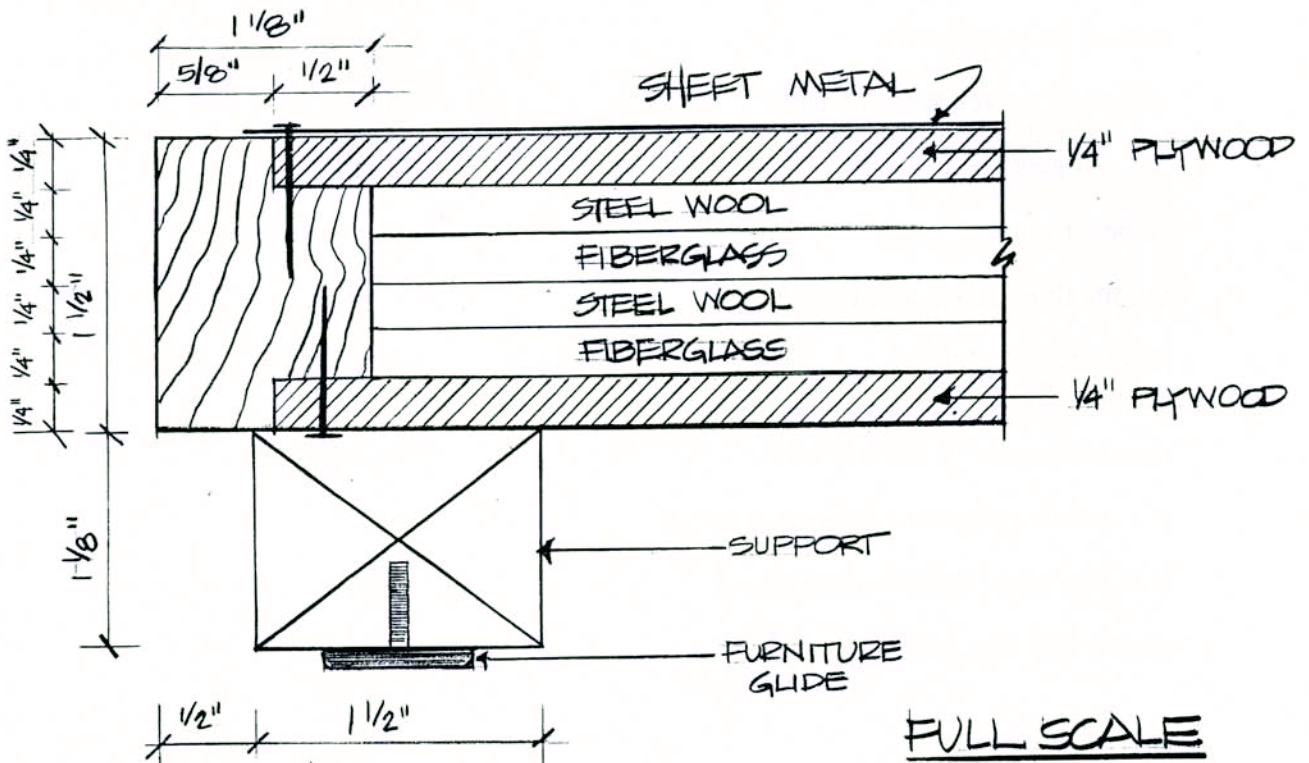

(FIG. 4) FRAMING DETAILS - SIDES (2), BACK, FRONT (DOOR), BOTTOM, TOP & SHOOTER BOX - SEAT (2)

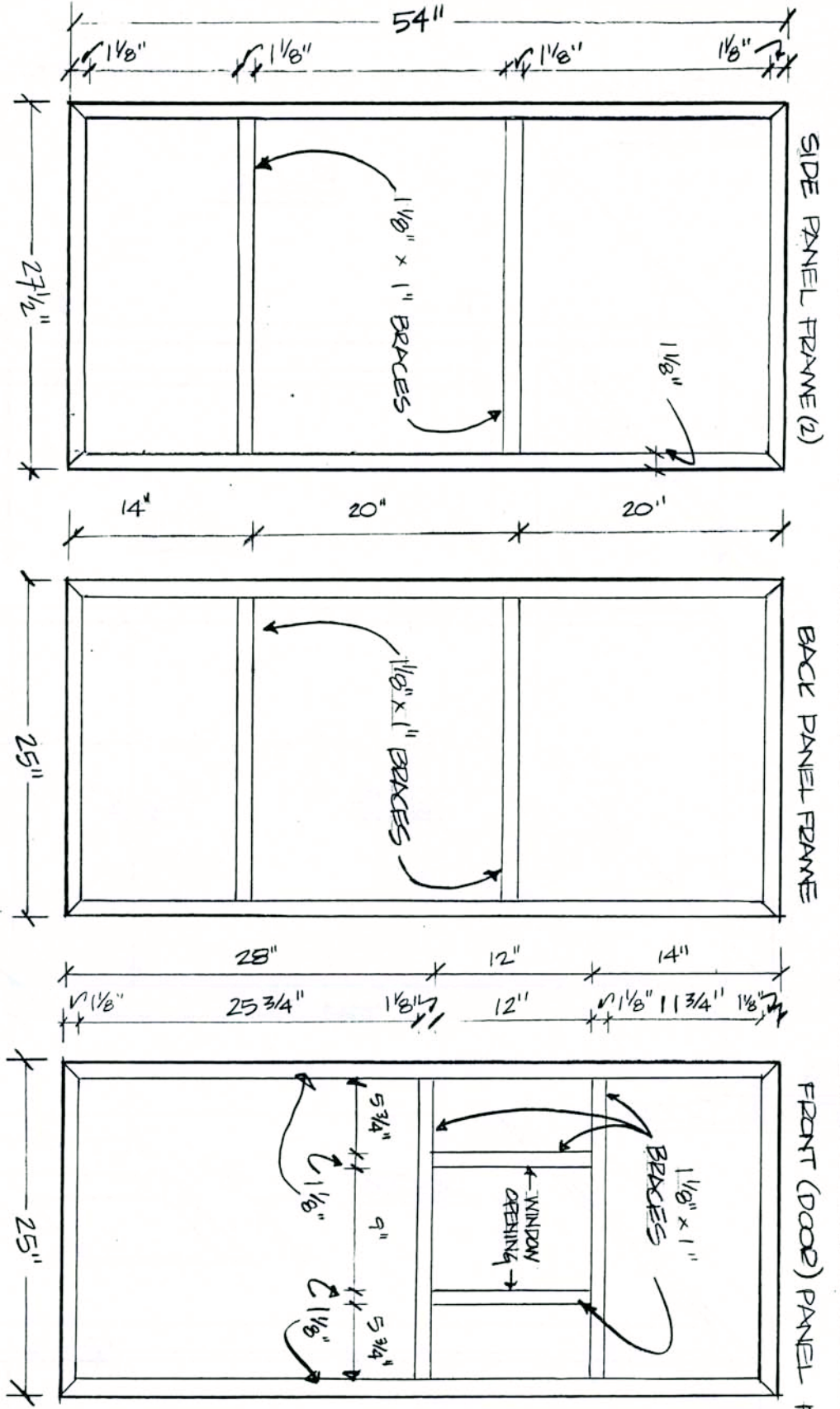

SIDES (2), BACK & FRONT (DOOR) PANEL FRAMES TO BE FASHIONED FROM 1 1/8" x 1 1/2" PINE WITH 1/2" x 1/2" RABBET (SEE FIG. 2)

BRACES TO BE 1 1/8" x 1" PINE.

SCALE: 1" = 1'-0"

NOTE: TOP & BOTTOM FRAMES HAVE SAME WIDTH, LENGTH AND THICKNESS.

BOTTOM FRAME CONSTRUCTED FROM 1 1/8" x 1 1/2" PINE WITH A 1/4" x 1/2" RABBET ON TWO SIDES (SEE FIG. 3)

TOP FRAME CONSTRUCTED FROM 1 1/8" x 1 1/2" PINE WITH A 1/2" RABBET ON ONE SIDE. (SEE FIG. 2)

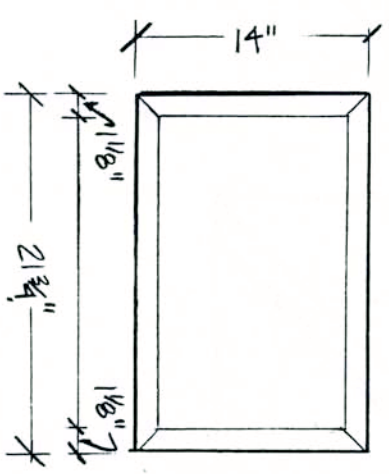
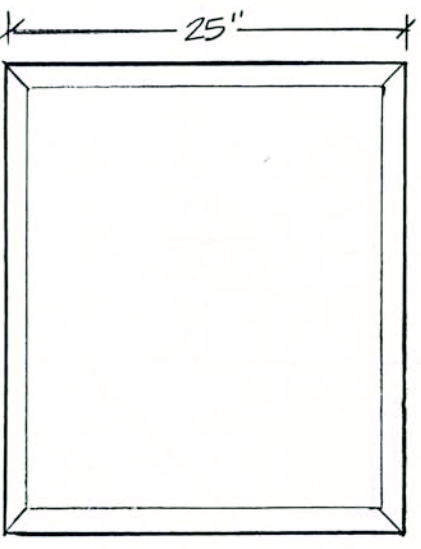

SHOOTER BOX SEAT (2)

FRAME TO BE CONSTRUCTED FROM 1 1/8" x 1 1/2" PINE WITH A 1/4" x 1/2" RABBET (SEE FIG. 7)

(FIG. 5)  
ASSEMBLING  
THE PANELS

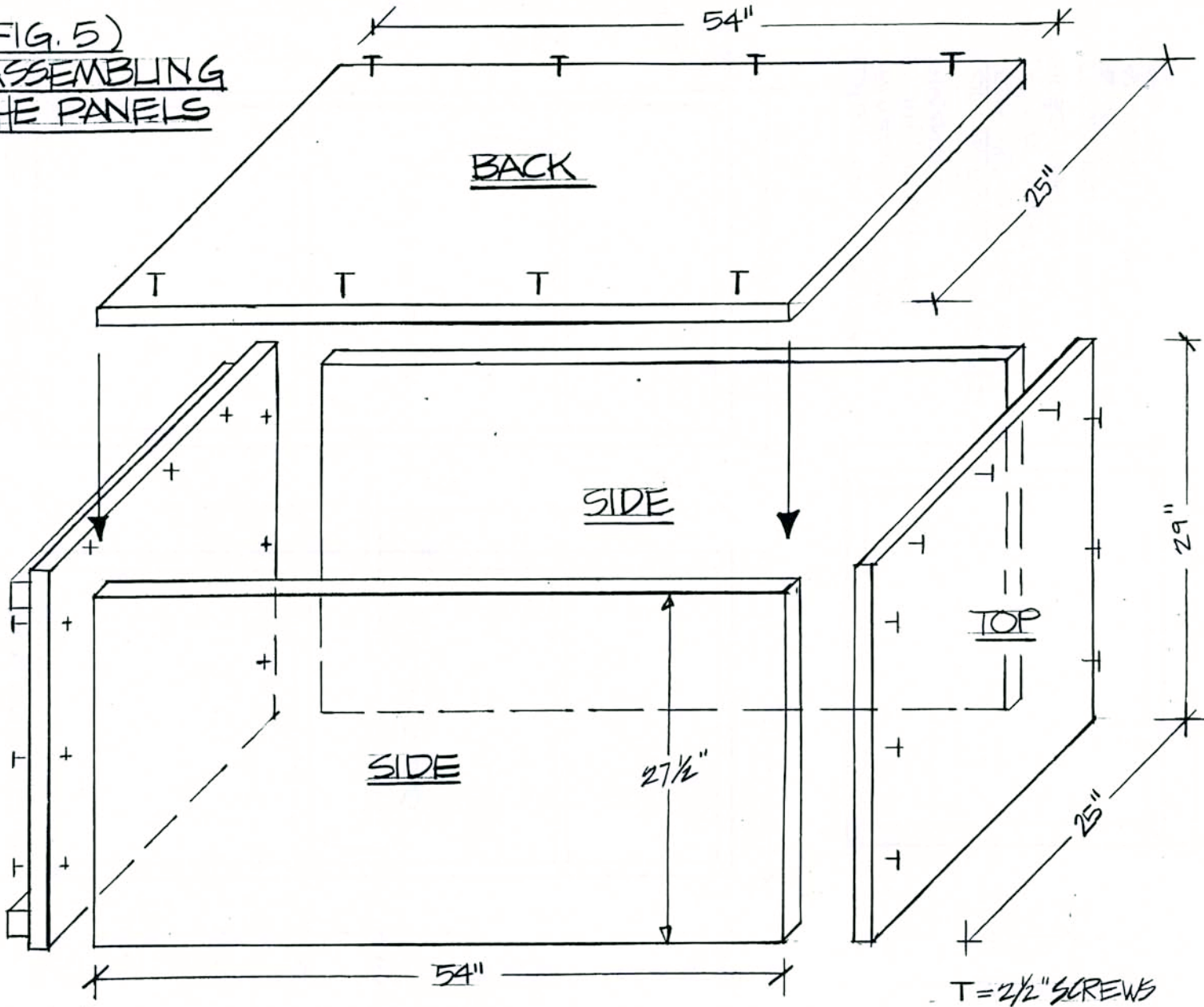

(FIG. 6)  
ATTACH DOOR

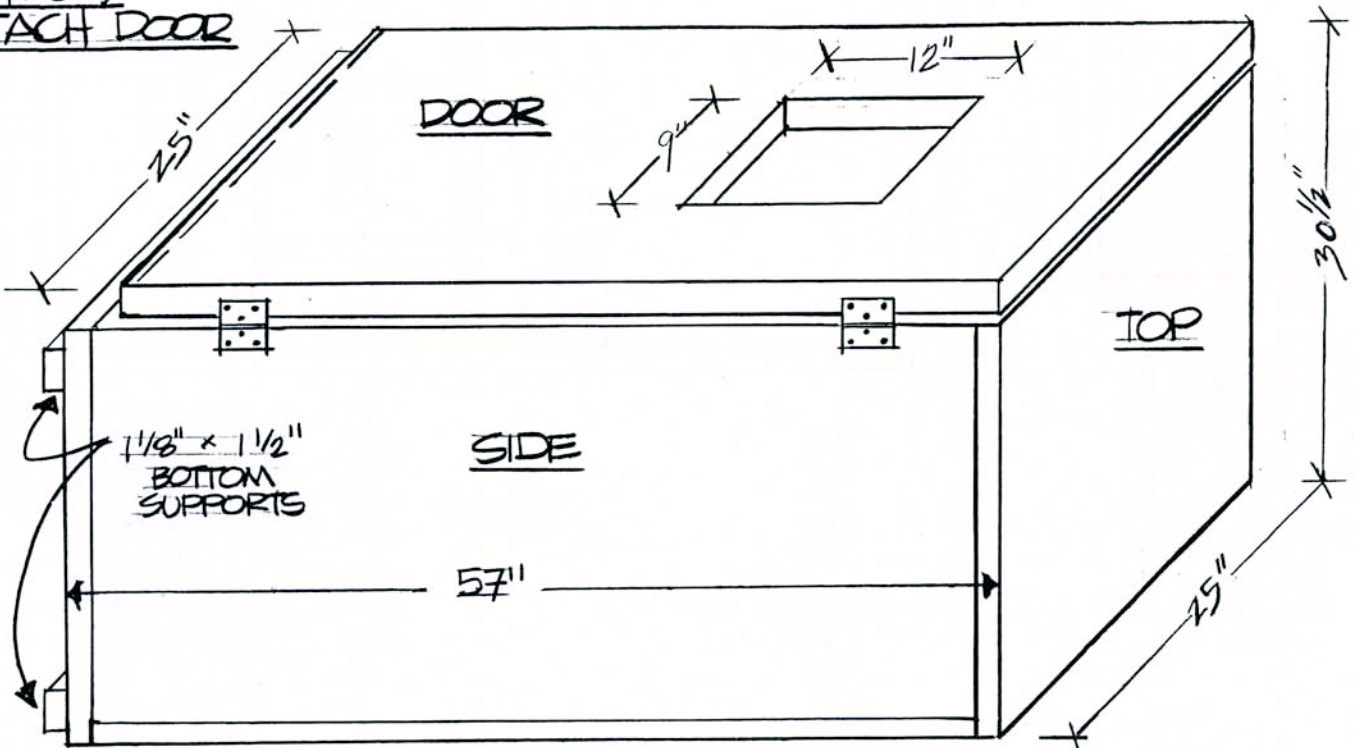

(FIG. 7) DETAIL FOR SHOOTER BOX - SEAT PANELS

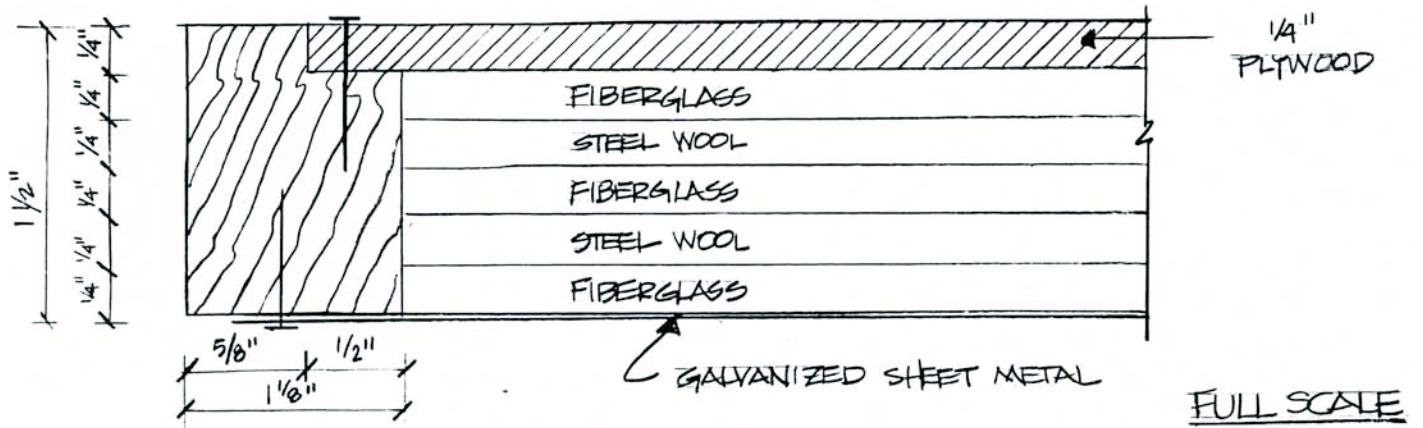

(FIG. 8) ASSEMBLING THE SHOOTER BOX - SEAT

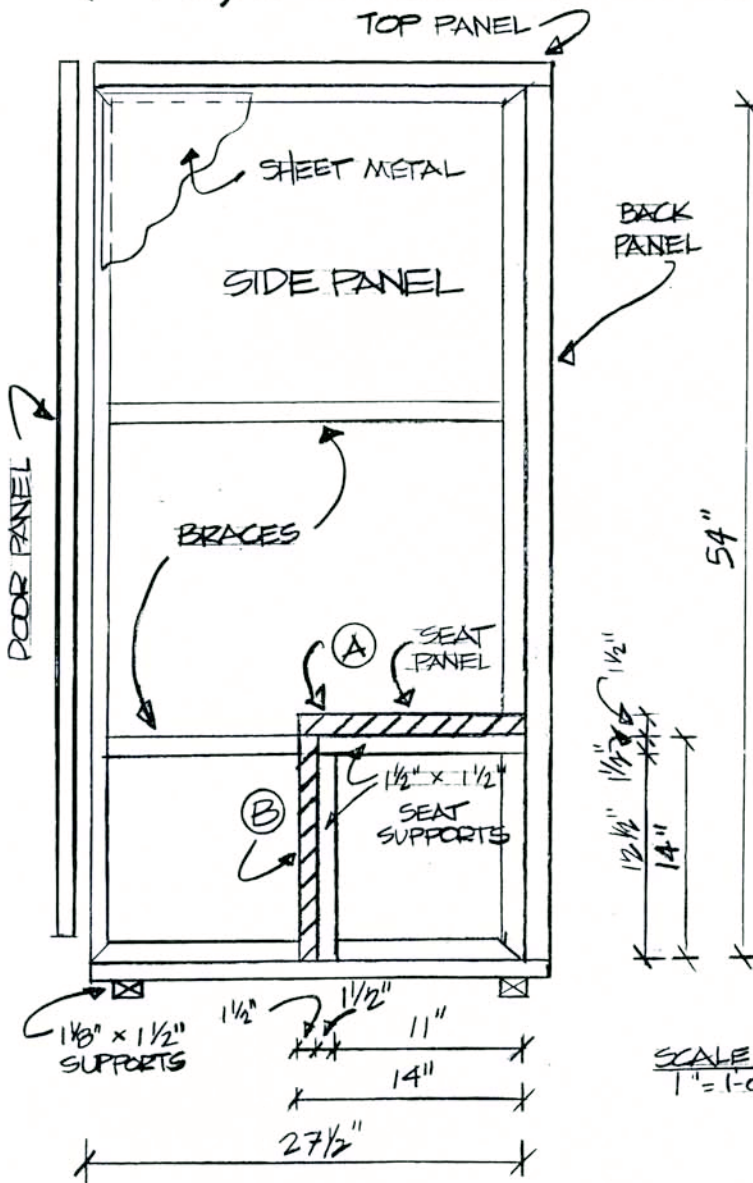

(FIG. 9) HOW TO USE CHEST PANEL

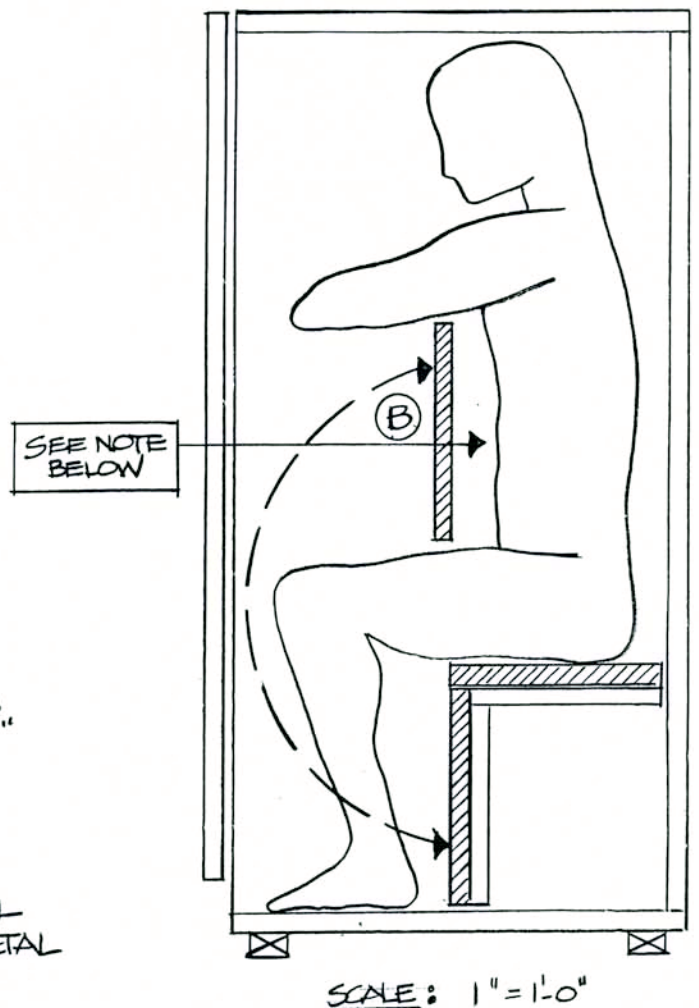

NOTE: ALLOW SPACE BETWEEN PANEL AND CHEST OF USER. SHEET METAL SIDE SHOULD FACE CHEST.